

D71A

1MP Outdoor Dome with D/N,
Adaptive IR, Fixed Lens



- 1 Megapixel with 720p
- Day & Night with Adaptive IR LED
- Fixed Lens with f2.93mm / F2.0
- 30 fps at 1280 x 720
- Weatherproof (IP66) and Vandal Proof (IK10)

PHOTO INDICATION

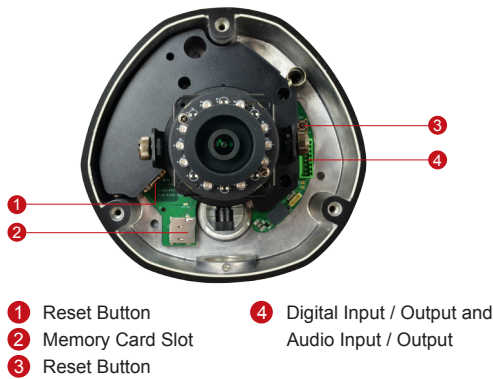



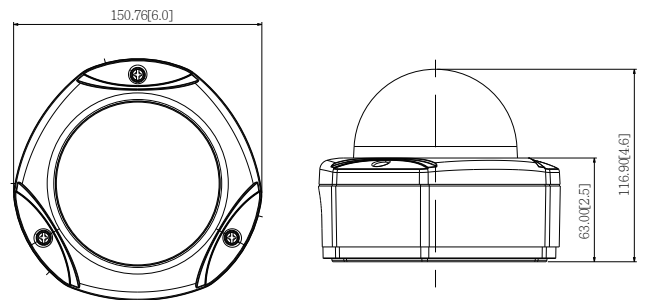



DIMENSION DIAGRAM



Unit: mm [inch]

ACCESSORY OPTIONS

Dome Cover		
PDCX-1101		4-inch, smoke, vandal proof

Popular Mounting Solutions	
Surface	Accessories not required
Wall	PMAX-0308 
Pendant	PMAX-0101 + PMAX-0103 
Corner	PMAX-0101 + PMAX-0305 + PMAX-0402 
Pole	PMAX-0101 + PMAX-0305 + PMAX-0503 
Flush	PMAX-1003 
Gang Box	PMAX-0804 

* For more mounting solutions, please refer to Project Planner on www.acti.com

PRODUCT SPECIFICATION**D71A****• Device**

Device Type	Outdoor Dome Camera
Image Sensor	Progressive Scan CMOS
Sensor Size	1/4"
Day / Night	Yes
Superior Low Light Sensitivity	No
Minimum Illumination	Color: 0.1 lux at F2.0 (30 IRE, 2400°K); B/W: 0 lux (IR LED on)
Color to B/W Switch	ISP based switch, configurable
Mechanical IR Cut Filter	Yes
IR Sensitivity Range	700~1100nm
IR LED	Adaptive IR LED (IR Exposure Compensation) x 10 (850nm)
IR Working Distance	15 m (0 lux, 30 IRE, Gain 255, Auto shutter mode)
Electronic Shutter	1/5 ~ 1/2,000 sec (manual mode); 1/5 ~ 1/10,000 sec (auto mode)

• Lens

Focal Length / Aperture	Fixed focal, f2.93 mm / F2.0
Iris	Fixed iris
Focus	Fixed focus
Mount Type	Board mount
Horizontal Viewing Angle	72.0°
Viewing Angle Adjustment	Pan: 0°~350°; Tilt: 17°~163°; Rotate: 0°~350°

• Video

Compression	H.264 HP, MJPEG
Max. Frame Rate vs. Resolution	30 fps at 1280 x 720; 30 fps at 640 x 480; 15 fps at 320 x 240
Multi-Streaming	Simultaneous dual streams based on two configurations
Bit Rate	28 Kbps - 6 Mbps (per stream)
Bit Rate Mode	Constant, Variable
Image Enhancement	White balance: automatic, hold, and manual; Brightness; Contrast; Sharpness (auto); Auto gain control; Digital noise reduction; Flickerless
Privacy Mask	4 configurable regions
Text Overlay	User defined text on video
Image Orientation	Image flip and mirror

• Audio

Compression	8 kHz, Mono, PCM, 16 bit encoding; G.711
Audio-In	Terminal block
Audio-Out	Terminal block

• Network

Protocol & Service	TCP, UDP, HTTP, HTTPS, DHCP, PPPoE, RTP, RTSP, IPv6, DNS, DDNS, NTP, ICMP, ARP, IGMP, SMTP, FTP, UPnP, SNMP, Bonjour
Ethernet Port	1, Ethernet (10/100 Base-T), RJ-45 connector
Security	IP address filtering; HTTPS encryption; Password protected user levels; Anonymous login; IEEE 802.1X network access control

• Alarm

Alarm Trigger	Video motion detection (3 regions)
Alarm Response	Notify control center; Change camera settings; Command other devices; E-mail notification with snapshots; Save video or snapshot to local storage; Upload video, snapshot to FTP; Activate external device through digital output

• Interface

Digital Input	1, Terminal block
Digital Output	1, Terminal block
Local Storage	MicroSDHC/MicroSDXC memory card slot (card not included)

• General

Power Source / Consumption	PoE Class 2 (IEEE802.3af) / 3.29 W (IR on)
Weight	975g (2.15lb)
Dimensions (Ø x H)	150.76 mm x 116.9 mm (6" x 4.6")
Environmental Casing	Weatherproof (IP66 rated); Vandal proof (IK10 rated); Transparent dome cover
Mount Type	Surface, Pendant, Wall, Corner, Pole, Flush, Gang box
Starting Temperature	-20°C ~ 50°C (-4°F ~ 122°F)
Operating Temperature	-40°C ~ 50°C (-40°F ~ 122°F)
Operating Humidity	10% ~ 85% RH
Approvals	CE (EN 55022 Class B, EN 55024), FCC (Part15 Subpart B Class B), IK10, IP66, NEMA 4X

• Integration

Unified Solution	Fully compatible with ACTi software
ISV Integration	Software Development Kit (SDK) available; ONVIF compliant
Firmware Access Browser	Microsoft Internet Explorer 8.0 or newer (full functionality) Safari with QuickTime installed, and other browsers with VLC installed (partial functionality)

* All specifications are subject to change without notice.

* All brand names and registered trademarks are the property of their respective owners.

www.acti.com